

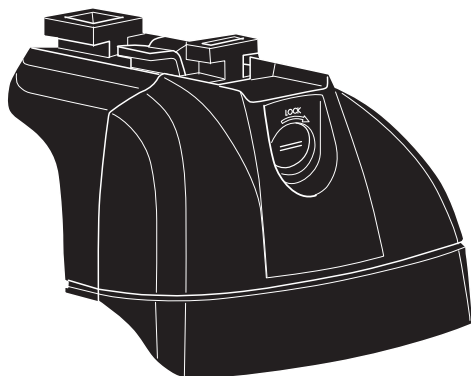

**THULE**<sup>®</sup>  
SWEDEN

# > Instructions

**Thule Rapid System**  
753000



**EN** Roof mounted load carrier  
**DE** Lastenträger zur Dachmontage  
**FR** Barre de toit  
**NL** Dakdrager  
**IT** Barra portatutto da installare sul tetto  
**ES** Portaequipajes de techo  
**PT** Barra para montagem no tejadilho  
**SV** Takmonterad lasthållare  
**DK** Tagmonteret lastholder  
**NO** Takmontert lasteholder  
**FI** Katolle asennettava teline  
**ET** Katusele paigaldatav katuseraam  
**LV** Uz jumta uzstādāms kravas turētājs  
**LT** Ant stogo tvirtinamas krovinų laikiklis  
**PL** Uchwyt na bagażnik bazowy montowany na dachu  
**RU** Багажник на крышу  
**UK** Багажник для даху  
**BG** Багажник, монтиран върху покрива  
**CS** Nosič pro montáž na střechu

**SK** Strešný nosič  
**SL** Nosilec za strešni prtljajnik  
**HR/BIH** Krovni nosač tereta  
**RO** Suport încărcătură montat pe acoperiș  
**HU** Tetőre szerelhető csomagszállító  
**EL** Σχάρα οροφής για μεταφορά φορτίου  
**TR** Araç üstüne bağlanan yük taşıyıcı

**HE** מנשא מטען לגג הרכב  
**AR** حامل نقل مثبت على السقف

**ZH** 頂置行李架  
**JA** ルーフマウント型ロードキャリア  
**KO** 루프 장착 화물 캐리어  
**TH** โครงยึดของบรรทุกแบบติดตั้งบนหลังคา

**CITY CRASH**

Complies with ISO norm

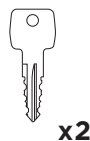
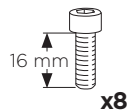
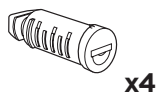
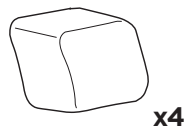
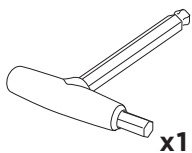
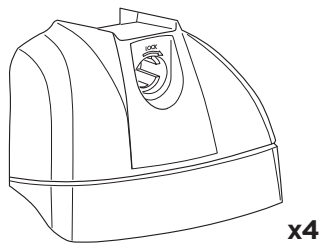
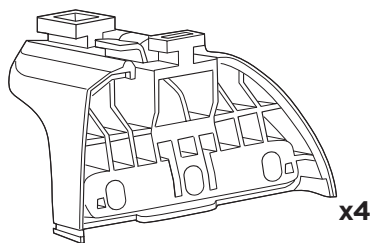
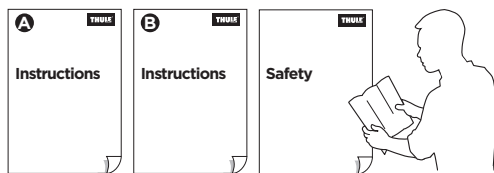



Your Key-Number

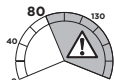
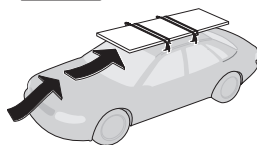
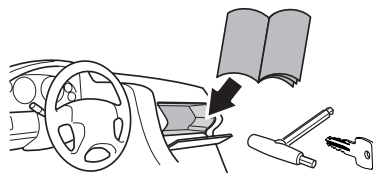

Max  
80 km/h  
50mph

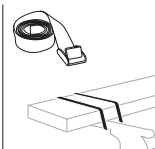
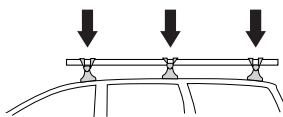

THULE  
WingBar Evo

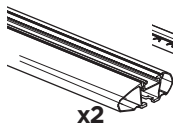

x2

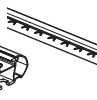

x2

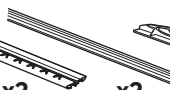

x2

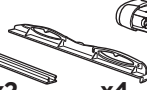

x4

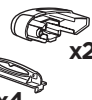

x2



x2



THULE  
WingBar

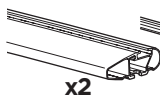

x2



x2

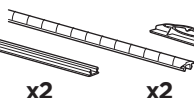

x2

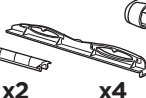

x2



x2



THULE  
SlideBar Evo

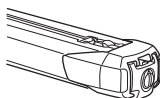

x2

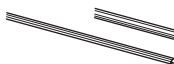

x2



x2



x1



x1



x2



THULE  
ProBar Evo

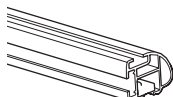

x2

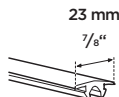

x2

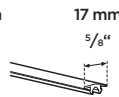

x2



x4



x4



x1



x2



x2



THULE  
SquareBar Evo



x2



x4

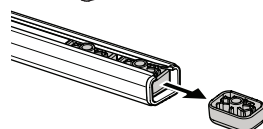

1

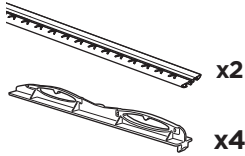
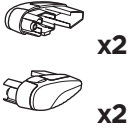

A

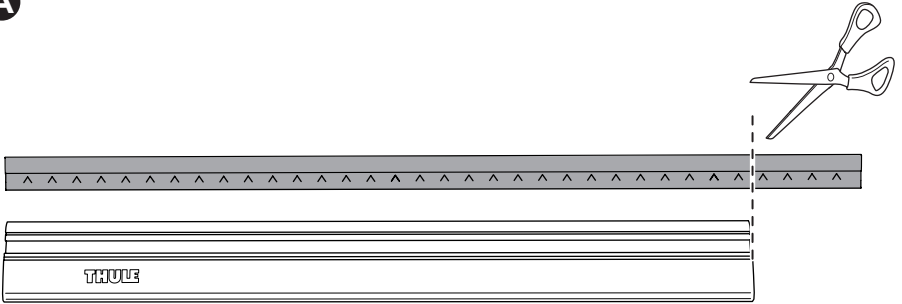

B

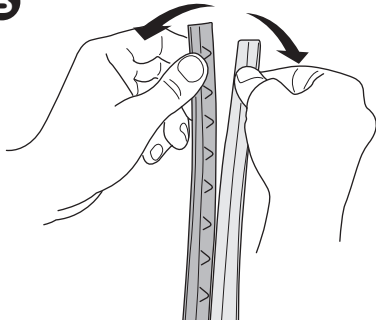

C

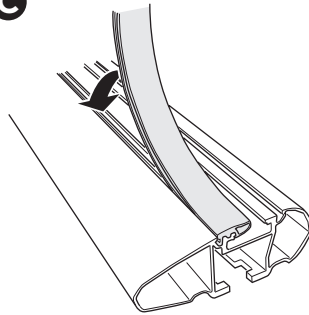

D

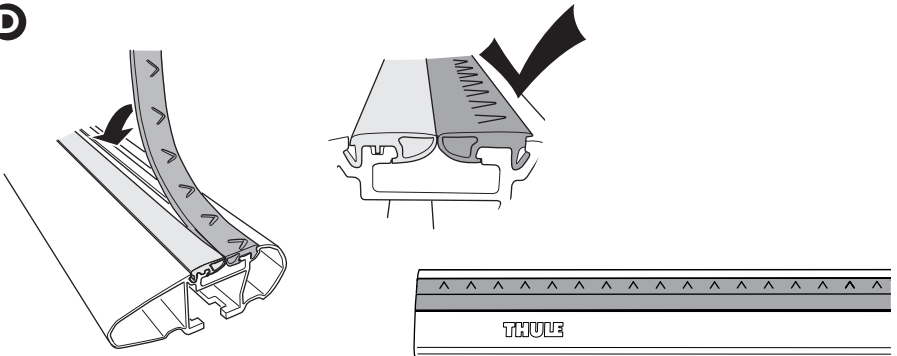

**E**

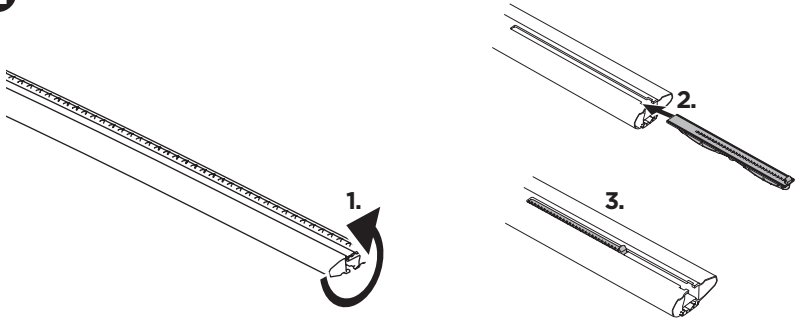

**F**

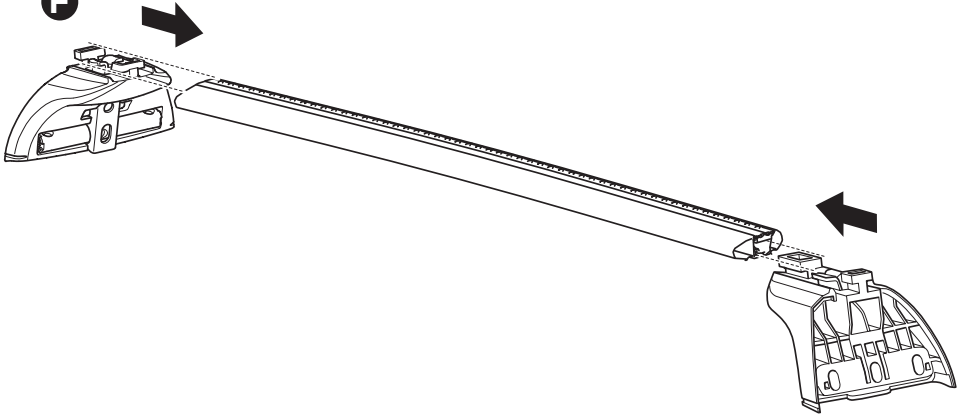

**G**

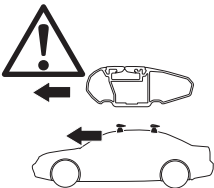
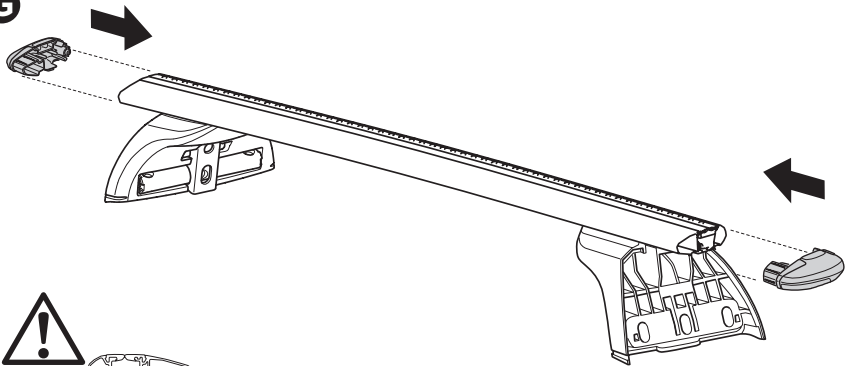

1



x2



x2



x2

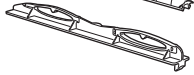

x4



A

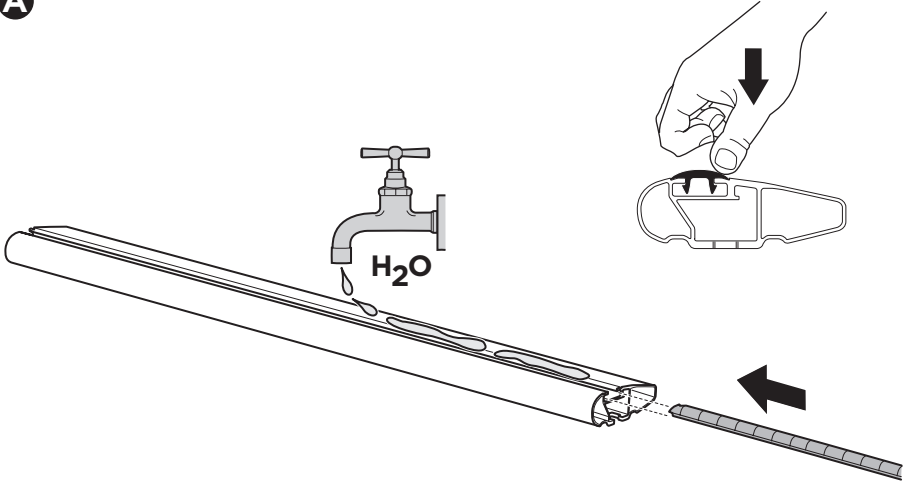

B

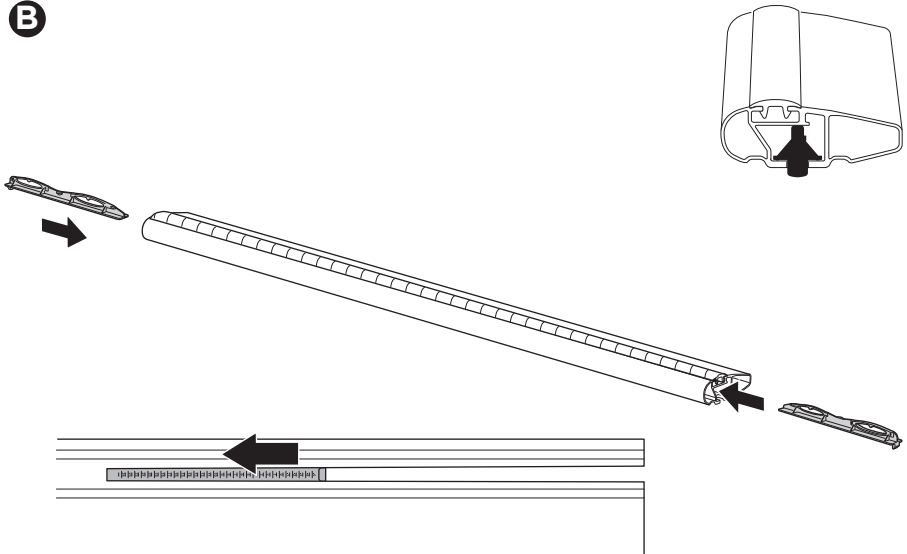

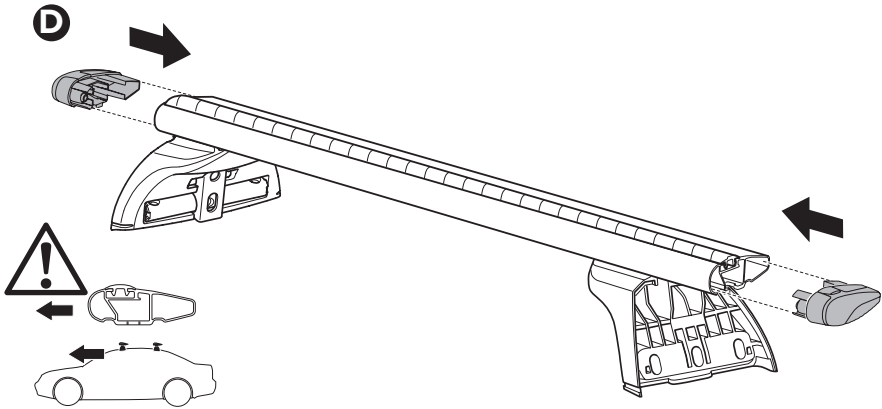
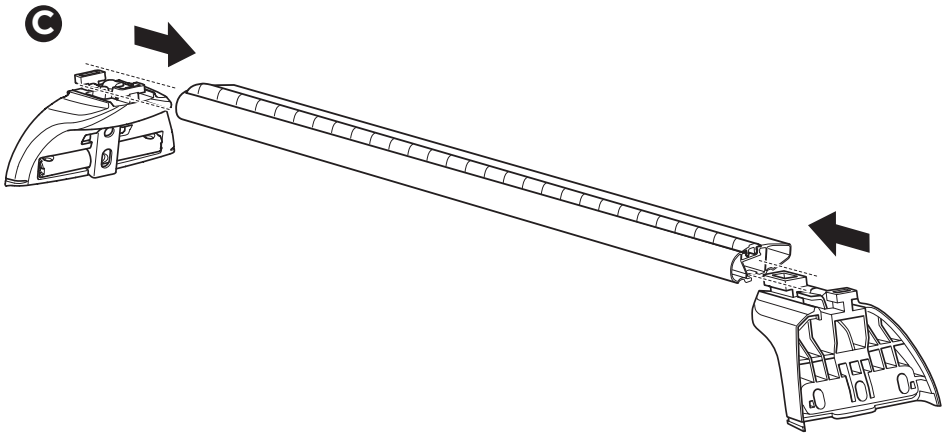

**1**

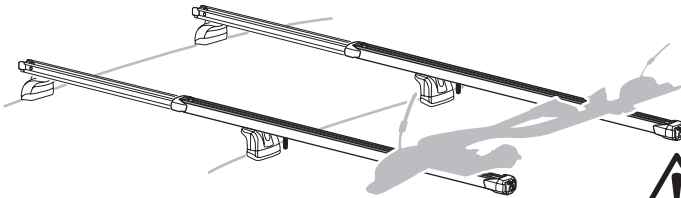

**THULE**  
SlideBar Evo

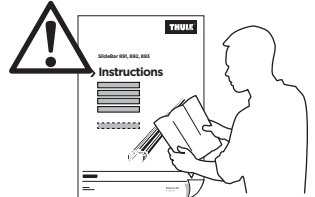

1



x4



x2

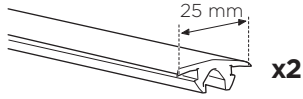

x2



x4



x2



x1

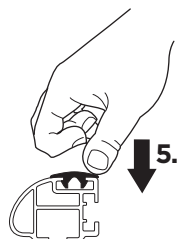
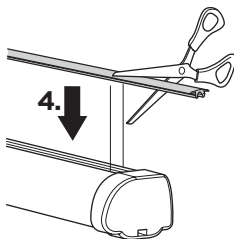
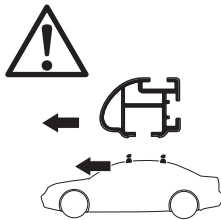
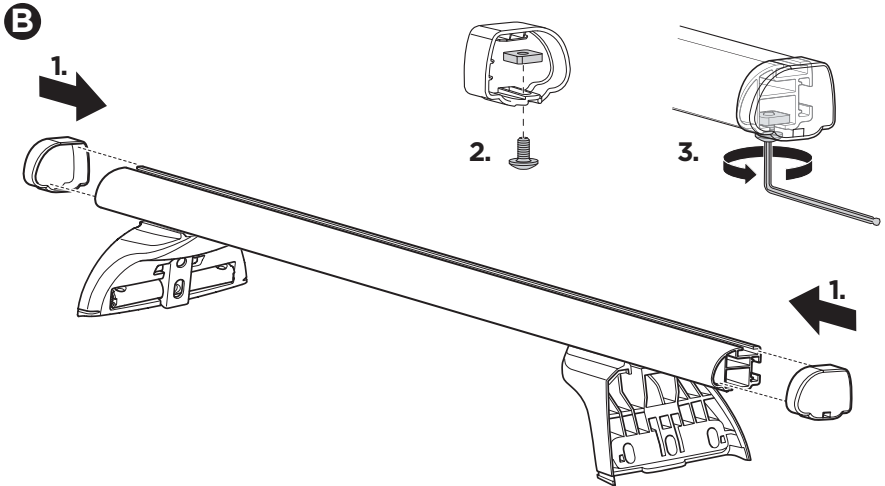
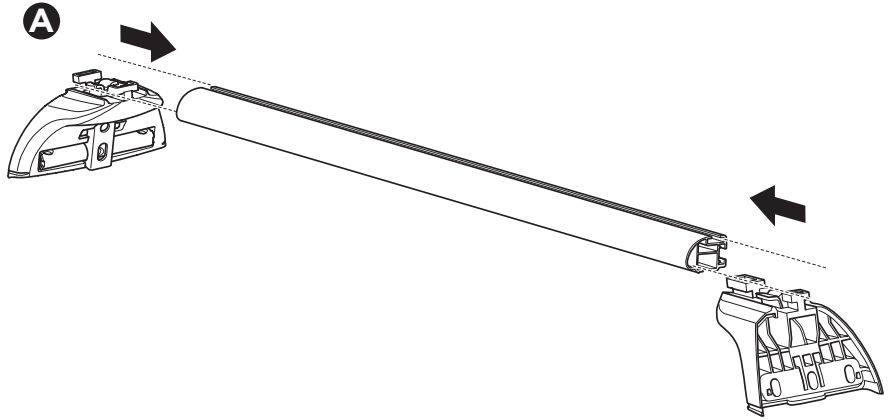



1

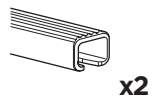

A

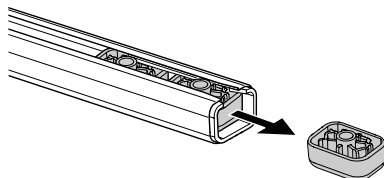
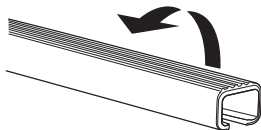

B

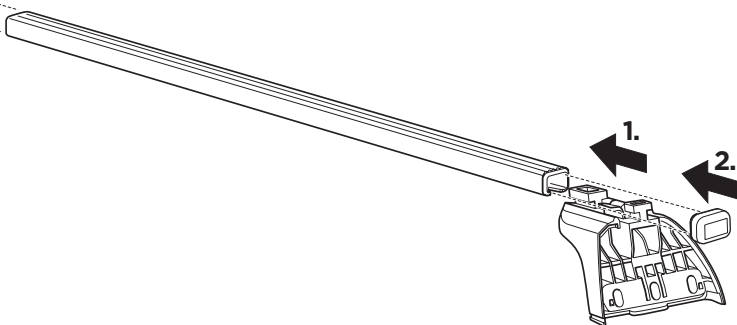
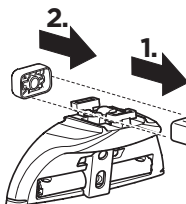

2

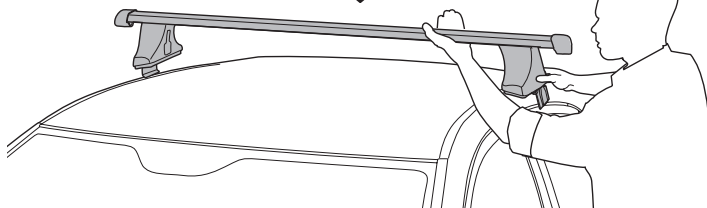
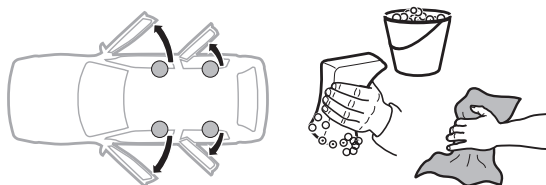

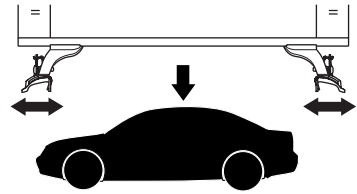
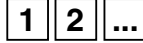
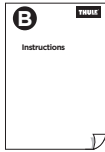

**EN IMPORTANT!** Move to KIT-manual and perform the car specific steps, before continuing with this instruction.

**DE WICHTIG!** Wechseln Sie zum KIT-Handbuch und führen Sie die fahrzeugspezifischen Schritte durch, bevor Sie mit dieser Anleitung fortfahren.

**FR IMPORTANT!** Avant de continuer ces instructions, passez au manuel du KIT et effectuez les étapes spécifiques au véhicule.

**NL BELANGRIJK!** Ga naar de KIT-handleiding en voer de specifieke stappen voor de auto uit voordat u verder gaat met deze instructie.

**IT IMPORTANTE!** Passare al Manuale KIT ed eseguire le fasi specifiche alla vettura, prima di proseguire con queste istruzioni.

**ES ¡IMPORTANTE!** Consulte el manual del KIT y realice los pasos específicos del coche antes de continuar con estas instrucciones.

**PT IMPORTANTE!** Avance para o manual do KIT e execute os passos específicos do automóvel, antes de continuar com esta instrução.

**SV VIKTIG!** Fortsätt med KIT-anvisningen och utför bilspecifika steg, fortsätt sedan med denna anvisningen.

**DK VIGTIG!** Tag brugsanvisningen til sættet, og notér de bilspecifikke oplysninger, før du går videre med denne vejledning.

**NO VIKTIG!** Gå til KIT-håndboken og gjør de bilspecifikke trinnene før du fortsetter med denne instruksjonen.

**FI TÄRKEÄ!** Siirry SARJA-oppaaseen ja tee autokohtaiset toimenpiteet, ennen kuin jatkat tätä ohjetta eteenpäin.

**ET NB!** Avage komplekti (KIT) juhend ja tehke andud autole nõutavad tööd ning alles seejärel jätkake käesolevate juhiste kohaselt.

**LV SVARĪGI!** Pirms turpināt izpildīt šajā pamācībā sniegtos norādījumus, skatiet KOMPLEKTA rokasgrāmatu un veiciet ar automobili saistītās darbības.

**LT SVARBU!** Prieš toliau vykdydami šią instrukciją pereikite prie KIT vadovo ir atlikite automobiliui skirtus veiksmus.

**PL WAŻNE!** Przed kontynuowaniem, wykonać czynności określone dla konkretnego samochodu w instrukcji KIT.

**RU ВАЖНО!** Обратитесь к руководству по эксплуатации комплекта и проделайте специфические для автомобиля шаги, прежде чем

продолжить выполнять требования настоящей инструкции.

**UK ВАЖЛИВО!** Зверніться до посібника з використання КОМПЛЕКТУ та виконайте специфічні для автомобіля кроки, перш ніж продовжити виконувати вимоги цієї інструкції.

**BG ВАЖНО!** Продължете с ръководството за употреба на КОМПЛЕКТА и изпълнете специфичните за автомобила стъпки преди да продължите с тази инструкция.

**CS DŮLEŽITÉ!** Předtím, než budete pokračovat s těmito pokyny, podívejte se na návod k SADĚ a proveďte kroky specifické pro vozidlo.

**SK DŮLEŽITÉ!** Predtým, než budete pokračovať s týmito pokynmi, sa pozrite na návod k SÚPRAVE a vykonajte kroky špecifické pre vozidlo.

**SL POMEMBNO!** Preden nadaljujete s tem navodilom, pojdite na priročnik kompleta in opravite korake, specifične za vaše vozilo.

**HR/BIH VAŽNO!** Prije nego nastavite s ovim uputama, prebacite se na priručnik seta i izvršite korake koje se odnose na automobil.

**RO IMPORTANT!** Consultați manualul KIT și efectuați etapele specifice autoturismului înainte de a continua cu această instrucțiune.

**HU FONTOS!** A hajtsa végre a készlet kézikönyvében található, az autóra vonatkozó lépéseket, mielőtt ezzel az útmutatással folytatja.

**EL ΣΗΜΑΝΤΙΚΟ!** Μεταβείτε στο εγχειρίδιο του KIT και εκτελέστε τα ειδικά βήματα για το αυτοκίνητο, πριν να συνεχίσετε με αυτήν την οδηγία.

**TR ÖNEMLI!** Bu talimatla devam etmeden önce KIT kilavuzuna gidin ve araca özel adımları gerçekleştirin.

**AR هام!** انتقل إلى دليل العمل KIT و قم بإجراء الخطوات الخاصة بالسيارة قبل متابعة التعليمات.

**HE חשוב!** עבור למדריך הקוט ובצע במכונית את השלבים המפורטים בו לפני המשך ביצוע הראות אלה.

**ZH 重要信息!** 在继续此说明之前, 先移到工具箱手册, 然后执行特定步骤。

**JA 重要!** この取付説明書を続ける前にKITマニュアルに行き、車固有のステップを行ってください。

**KO 중요!** 이 지침을 계속 진행하기 전에 KIT 설명서로 이동하여 해당 차량에만 해당하는 단계를 수행하십시오.

**TH สำคัญ!** ย้ายไปที่คู่มือ KIT และปฏิบัติตามขั้นตอนเฉพาะของรถยนต์ ก่อนดำเนินการตามคำแนะนำ

3



x4



x2

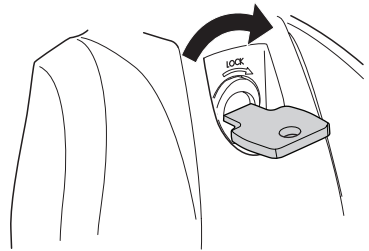
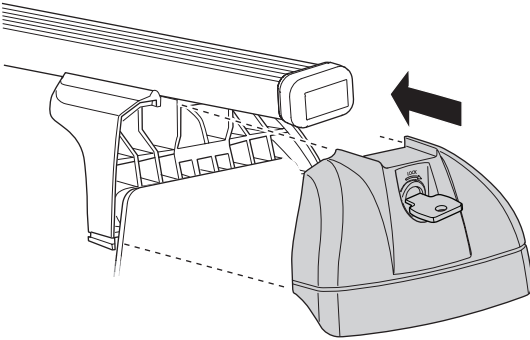
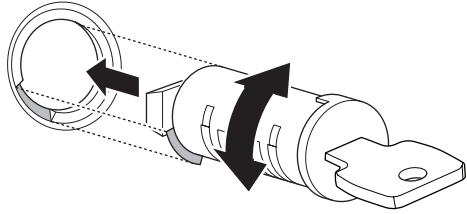
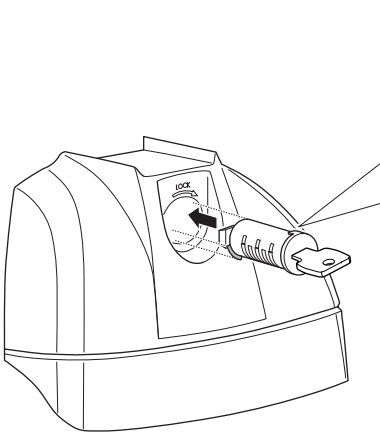

4

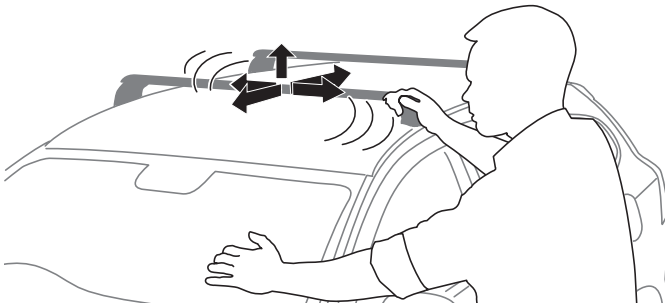

5

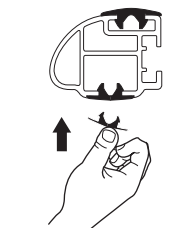
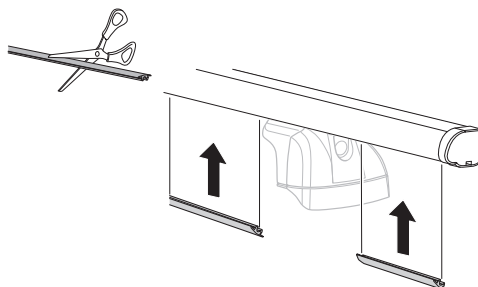
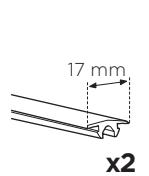
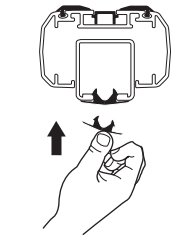
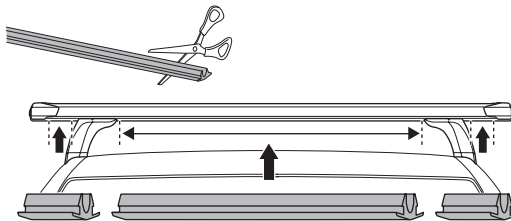
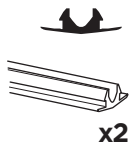
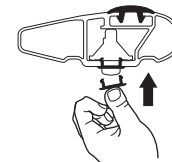
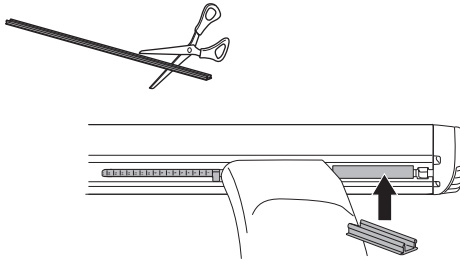
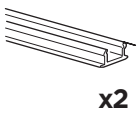
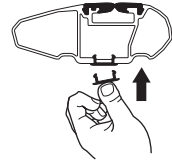
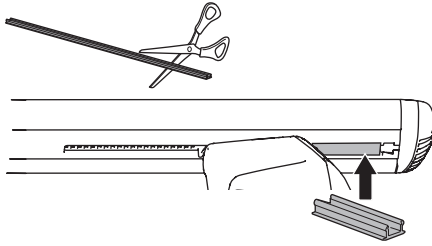
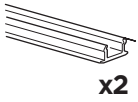

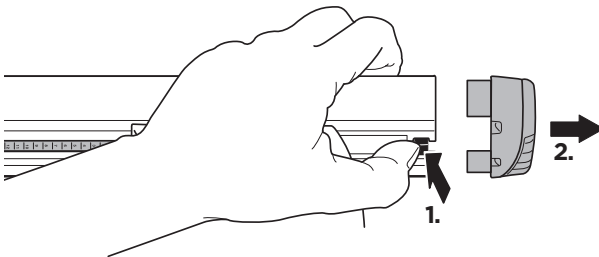
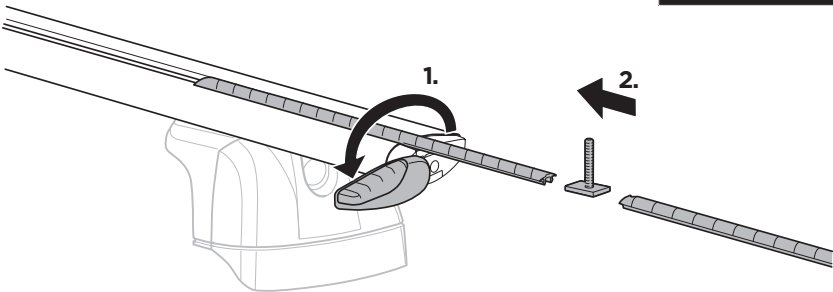
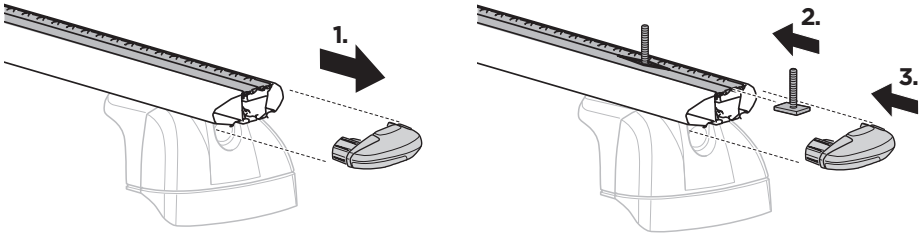

**i**



THULE  
SlideBar Evo

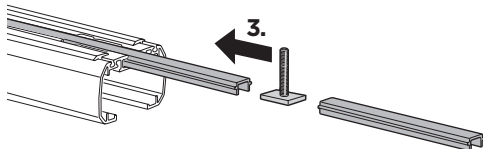
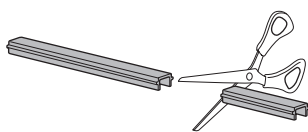
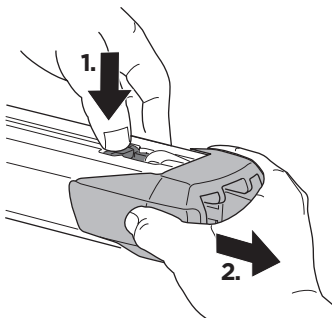

THULE  
ProBar Evo

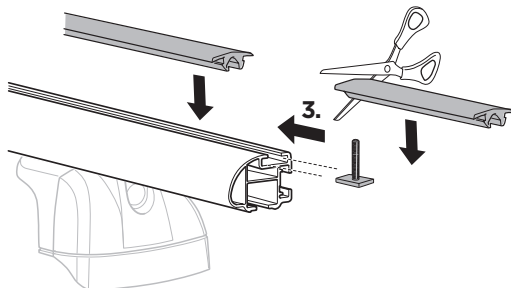
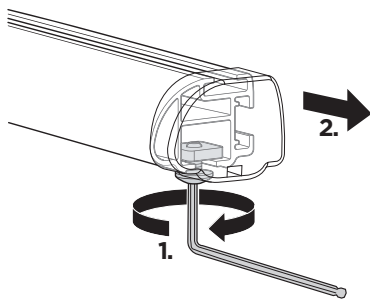

## Thule One-Key System

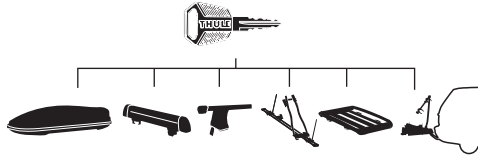

**450400**  (x4)

**450600**  (x6)

**450800**  (x8)

**451200**  (x12)

**451600**  (x16)



Thule Sweden AB, Borggatan 5  
335 73 Hillerstorp, SWEDEN

» PART OF THULE GROUP



info@thule.com

© Thule Group 2019 All rights reserved.



www.thule.com

501-7697-08